

## 05230700 - LT-S VDI50 DIN138-22 H98

Type	LT-S Tool holder straight
Mounting	VDI 50
Tool output	Shell-Mill DIN138 22
Coolant	External coolant
Direction of rotation	r1 ↻ r2 ↻
Max speed [rpm]	6000
Max torque [Nm]	120
Ratio	1:1
H [mm]	98
Accessories	N.A.
Notes	N.A.
Mounting tips	N.A.

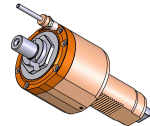

**ATTENTION: CHECK THE ORIENTATION OF THE VDI TEETH**

Always check live tool dimensions on the turret

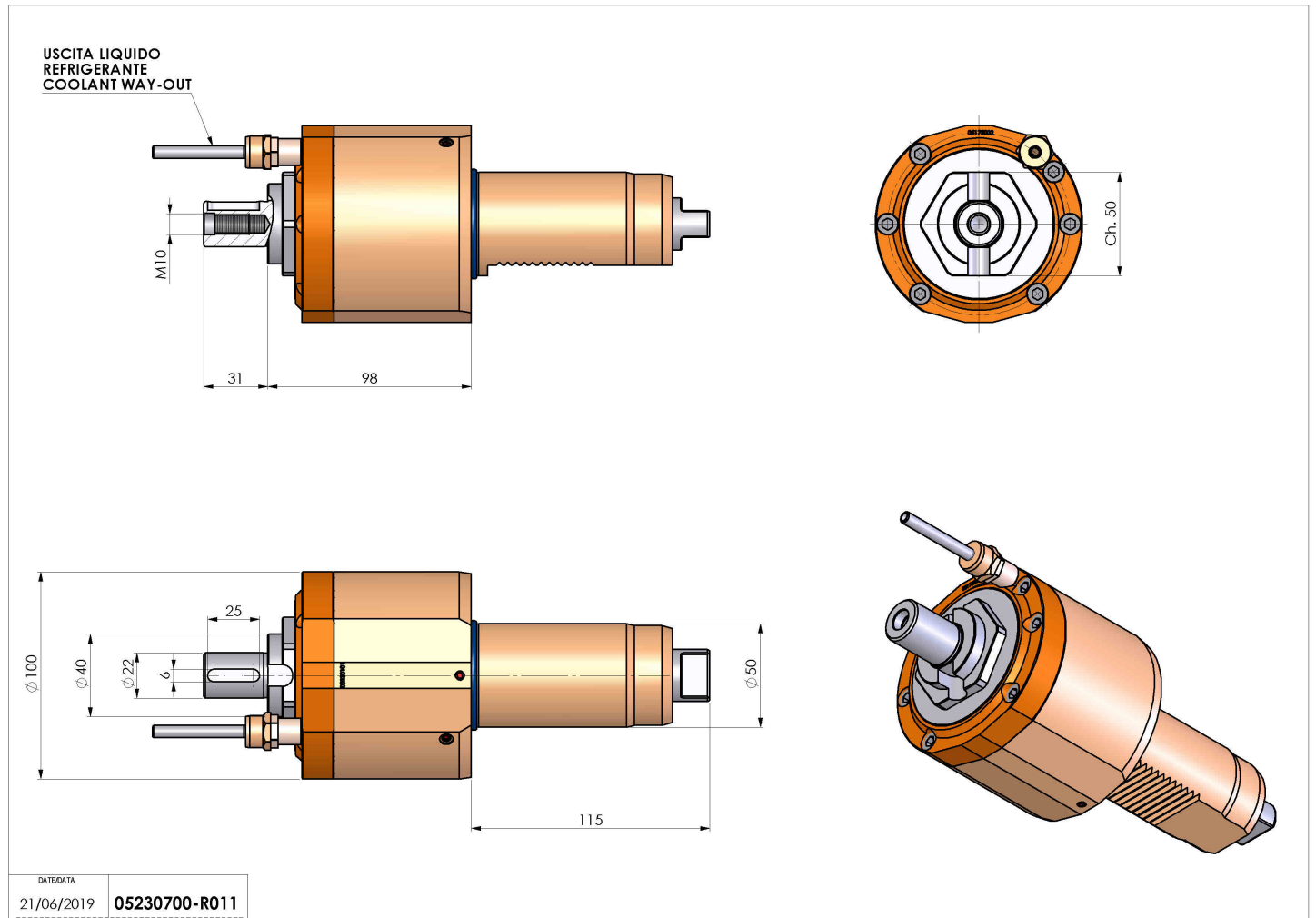

Subject to technical changes