



05227200 - LT-SVDI40ER32FOFS51RF1:2H11SA

Type	LT-S OFS Tool holder straight offset
Mounting	VDI 40
Tool output	Collet nut ER 32 F - internal nut
Coolant	Internal coolant
Offset [mm]	51
Direction of rotation	r1  r2 
Max speed [rpm]	in 6000 / out 12000
Max torque [Nm]	in 50 / out 25
Ratio	1:2
H [mm]	111
Max pressure [bar]	20
Accessories	N.A.
Notes	N.A.
Mounting tips	N.A.

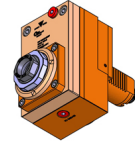

ATTENTION: CHECK THE ORIENTATION OF THE VDI TEETH

Always check live tool dimensions on the turret

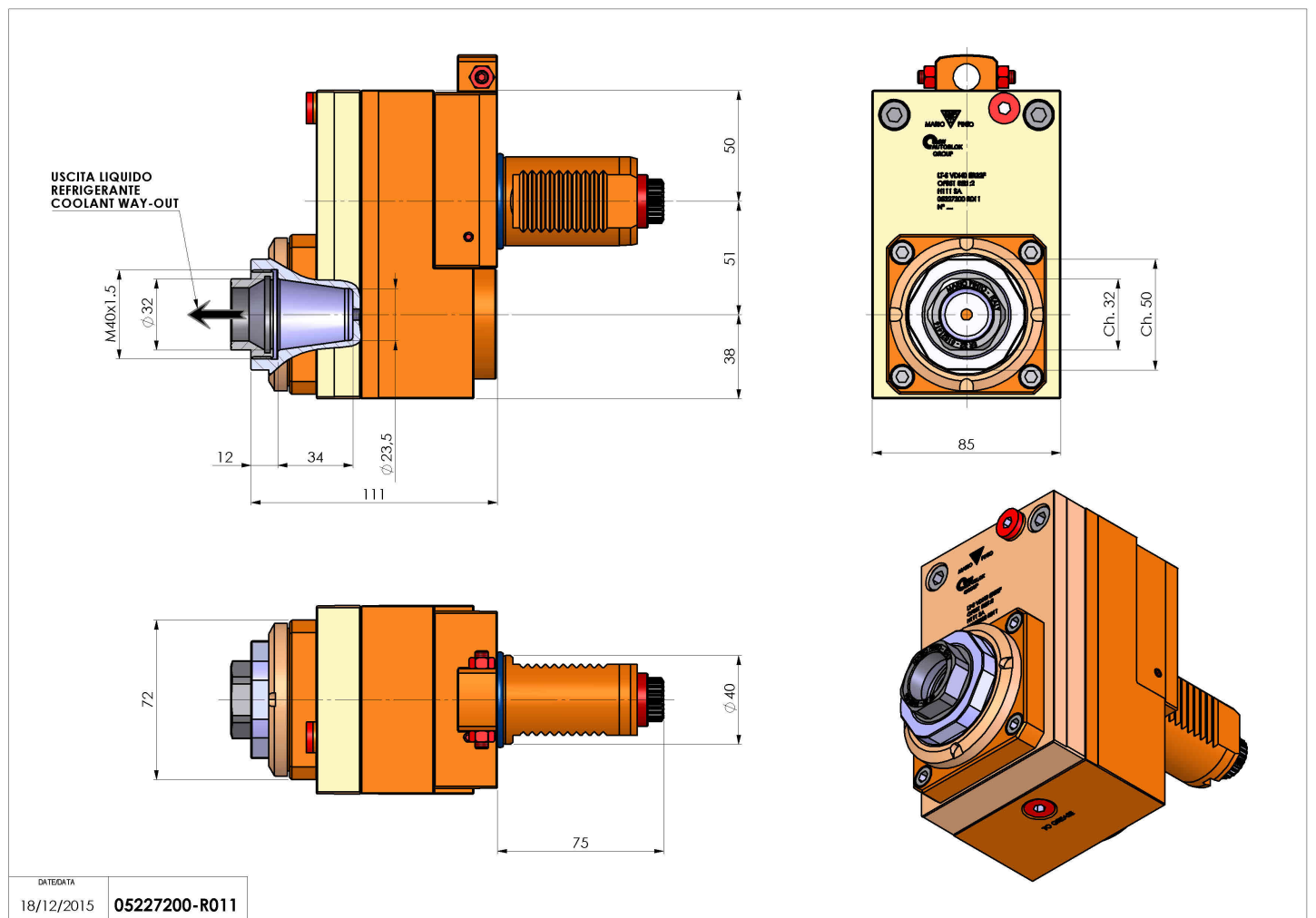

Subject to technical changes