

05221300 - LT-A VDI30 ER25F RF H65 5480SA

Type	LT-A Tool holder angle 90°
Mounting	VDI 30
Tool output	Collet nut ER 25 F - internal nut
Coolant	Internal coolant
Direction of rotation	r1 ↻ r2 ↻
Max speed [rpm]	6000
Max torque [Nm]	30
Ratio	1:1
H [mm]	65
H1 [mm]	32,5
Max pressure [bar]	20
Accessories	N.A.
Notes	N.A.
Mounting tips	Verify VDI position betw. turret and live tool

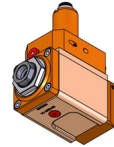

ATTENTION: CHECK THE ORIENTATION OF THE VDI TEETH

Always check live tool dimensions on the turret

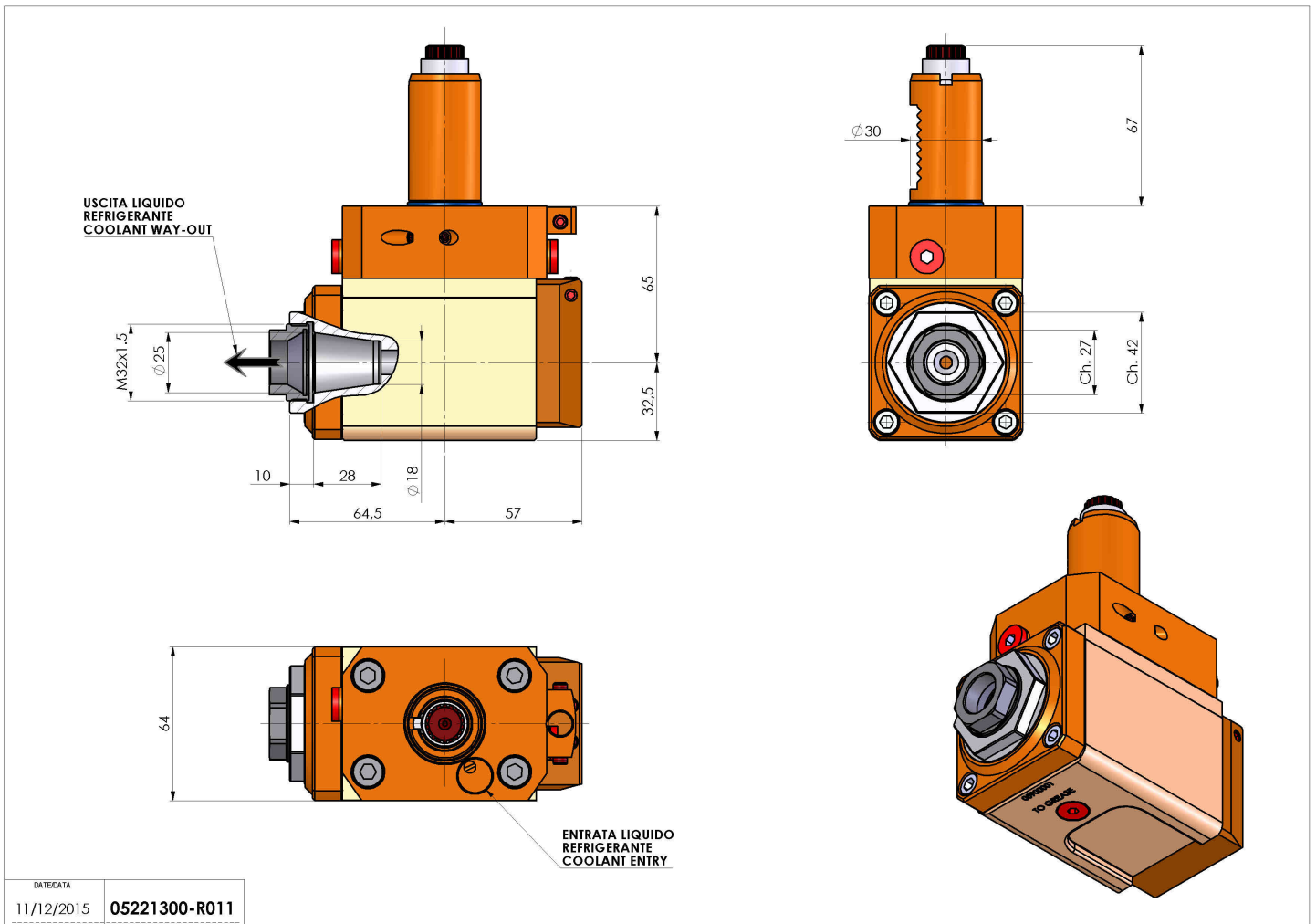

DATE/GRA	11/12/2015	05221300-R011
----------	------------	---------------

Subject to technical changes