

## 05161300 - LT-A D35 ER20F RF 2:1 H60 MU

<b>Type</b>	LT-A Tool holder angle 90°
<b>Mounting</b>	CYLINDRICAL SHANK 35
<b>Tool output</b>	Collet nut ER 20 F - internal nut
<b>Coolant</b>	Internal coolant
<b>Direction of rotation</b>	r1 ↻ r2 ↻
<b>Max speed [rpm]</b>	in 6000 / out 3000
<b>Max torque [Nm]</b>	in 10 / out 20
<b>Ratio</b>	2:1
<b>H [mm]</b>	60
<b>H1 [mm]</b>	28
<b>Max pressure [bar]</b>	20
<b>Accessories</b>	N.A.
<b>Notes</b>	N.A.
<b>Mounting tips</b>	N.A.

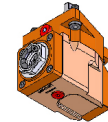

Always check live tool dimensions on the turret

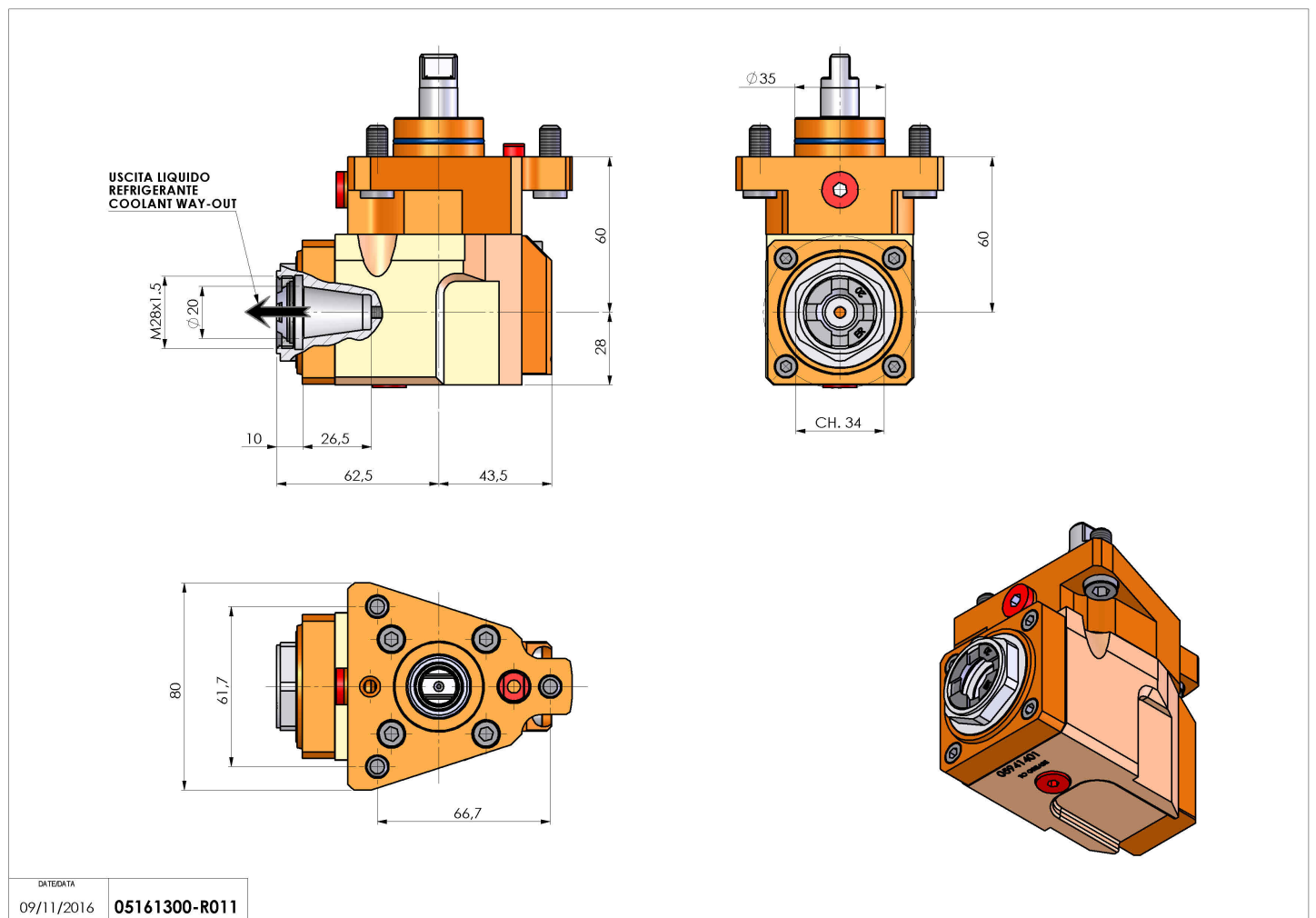

DATE/DATE	09/11/2016
	05161300-R011

Subject to technical changes