

05127700 - LT-S BMT55 DIN138-16 H57 DW

Type	LT-S Tool holder straight
Mounting	BMT 55
Tool output	Shell-Mill DIN138 16
Coolant	External coolant
Direction of rotation	r1 r2
Max speed [rpm]	6000
Max torque [Nm]	40
Ratio	1:1
H [mm]	57
Accessories	
Notes	N.A.
Mounting tips	N.A.

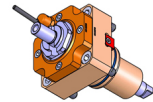

Always check live tool dimensions on the turret

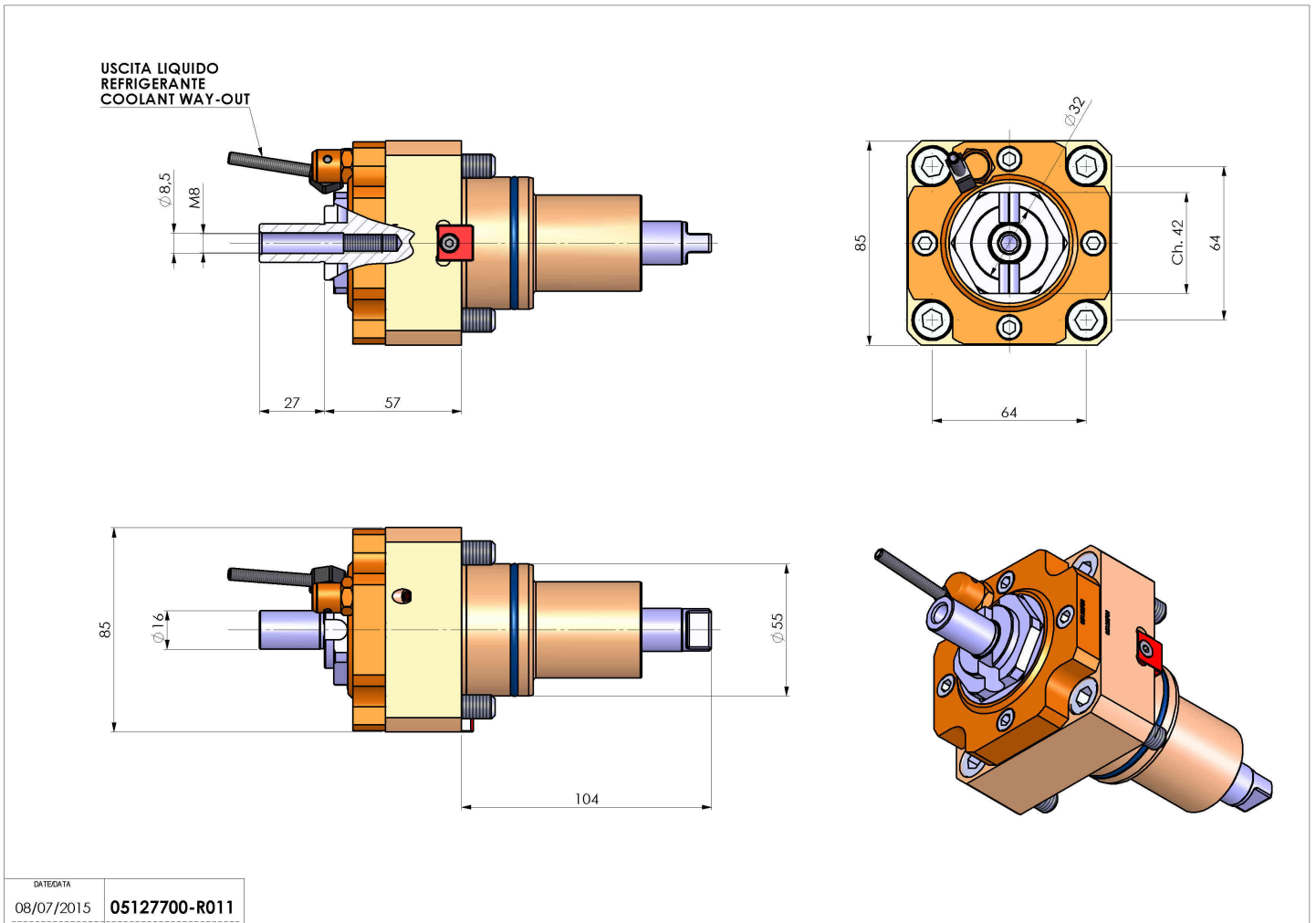

DATE/DATE	
08/07/2015	05127700-R011

Subject to technical changes