

# 05125900 - LT-A BMT85 ER50 LR H85

<b>Type</b>	LT-A Tool holder angle 90°
<b>Mounting</b>	BMT 85
<b>Tool output</b>	Collet nut ER 50
<b>Coolant</b>	External coolant
<b>Direction of rotation</b>	r1 ↻ r2 ↻
<b>Max speed [rpm]</b>	4000
<b>Max torque [Nm]</b>	180
<b>Ratio</b>	1:1
<b>H [mm]</b>	85
<b>H1 [mm]</b>	52
<b>Accessories</b>	N.A.
<b>Notes</b>	N.A.
<b>Mounting tips</b>	N.A.

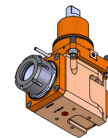

Always check live tool dimensions on the turret

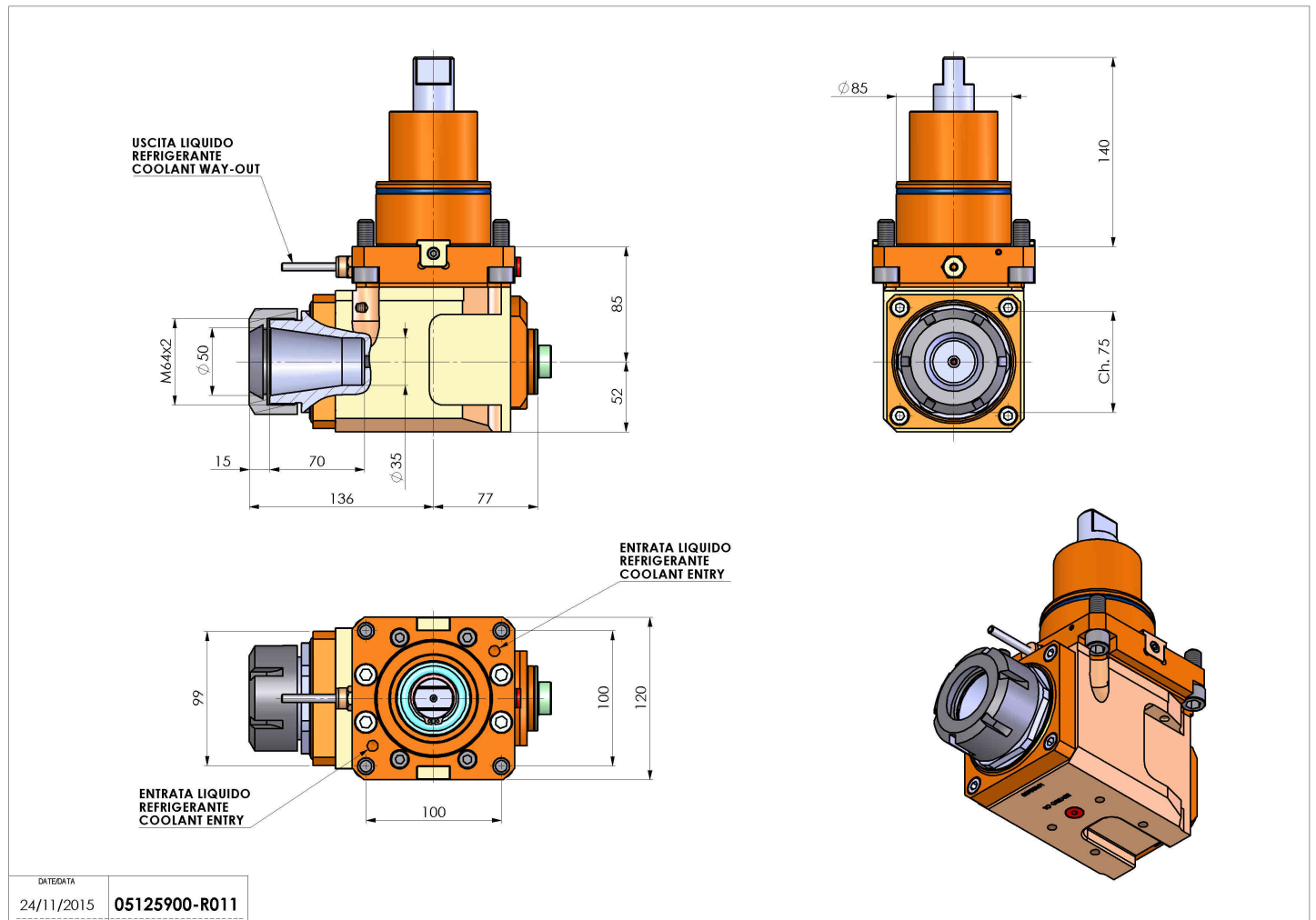

Subject to technical changes