

05122200 - LT-A BMT65 ER32F LR RF H72

Type	LT-A Tool holder angle 90°
Mounting	BMT 65
Tool output	Collet nut ER 32 F - internal nut
Coolant	Internal coolant
Direction of rotation	r1 ↻ r2 ↻
Max speed [rpm]	6000
Max torque [Nm]	63
Ratio	1:1
H [mm]	72
H1 [mm]	38
Max pressure [bar]	20
Accessories	N.A.
Notes	N.A.
Mounting tips	N.A.

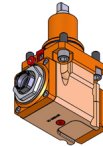

Always check live tool dimensions on the turret

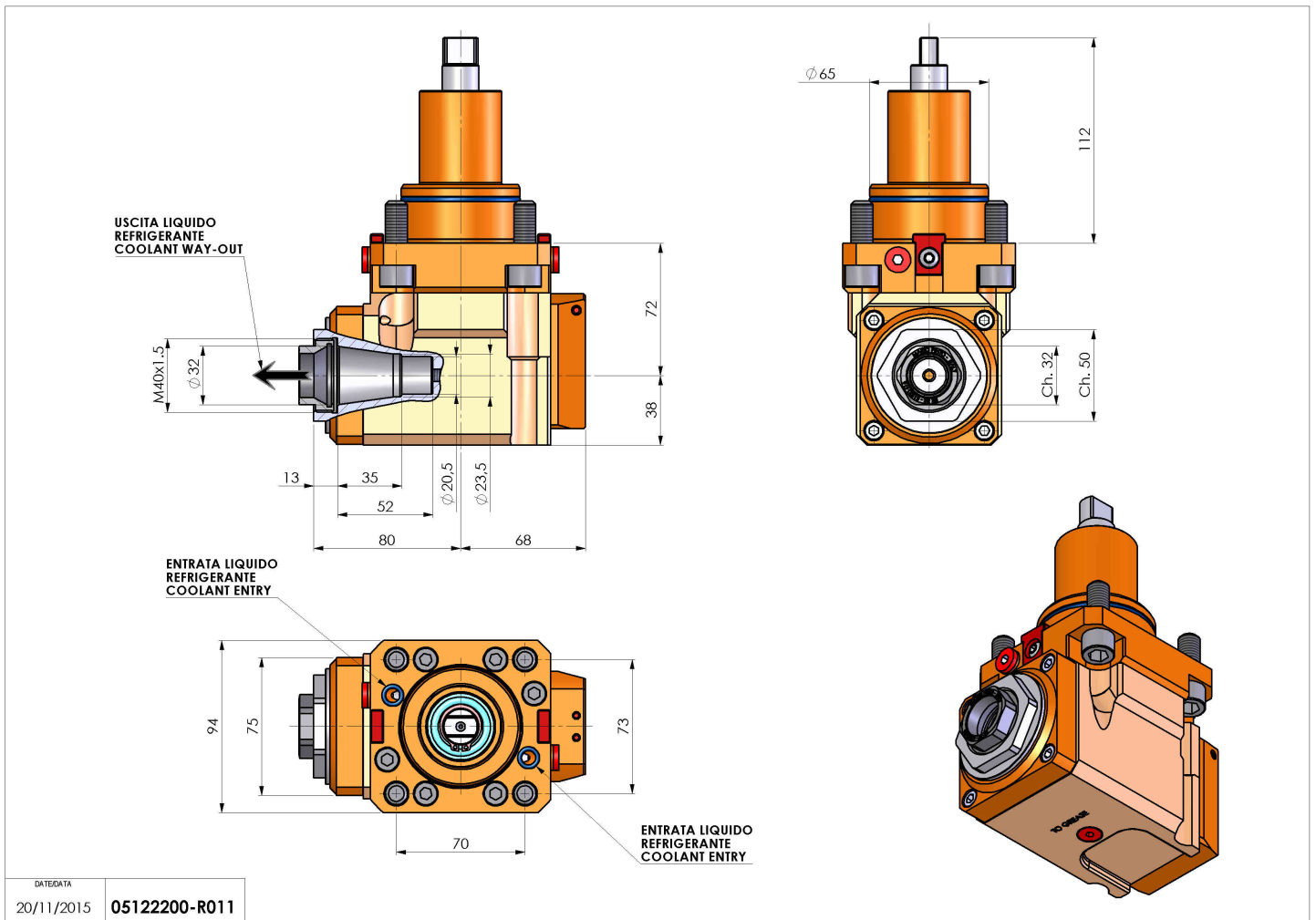

DATE/DATE	05122200-R011
20/11/2015	

Subject to technical changes