

05114500 - LT-A VDI40 DIN22 H75 130 HA

Type	LT-A Tool holder angle 90°
Mounting	VDI 40
Tool output	Shell-Mill DIN138 22
Coolant	External coolant
Direction of rotation	r1 ↻ r2 ↻
Max speed [rpm]	6000
Max torque [Nm]	63
Ratio	1:1
H [mm]	75
H1 [mm]	38
Accessories	N.A.
Notes	N.A.
Mounting tips	N.A.

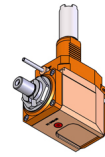

ATTENTION: CHECK THE ORIENTATION OF THE VDI TEETH

Always check live tool dimensions on the turret

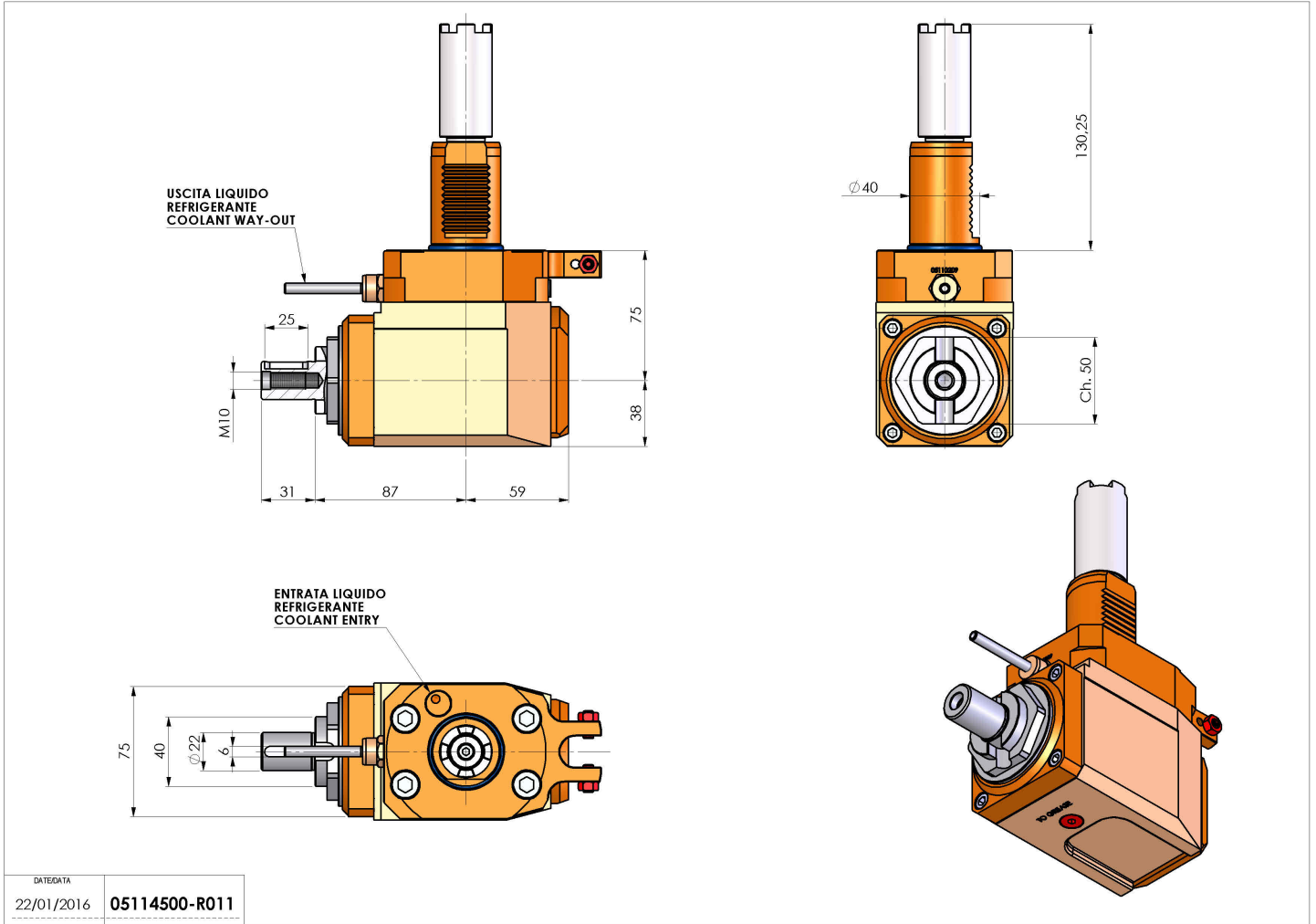

DATE/DATE	05114500-R011
22/01/2016	

Subject to technical changes