



05085500 - LT-S D40 DIN138-22 H81 AN

Type	LT-S Tool holder straight
Mounting	CYLINDRICAL SHANK 40
Tool output	Shell-Mill DIN138 22
Coolant	External coolant
Direction of rotation	r1  r2 
Max speed [rpm]	6000
Max torque [Nm]	63
Ratio	1:1
H [mm]	81
Accessories	
Notes	N.A.
Mounting tips	N.A.



Always check live tool dimensions on the turret

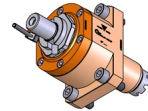
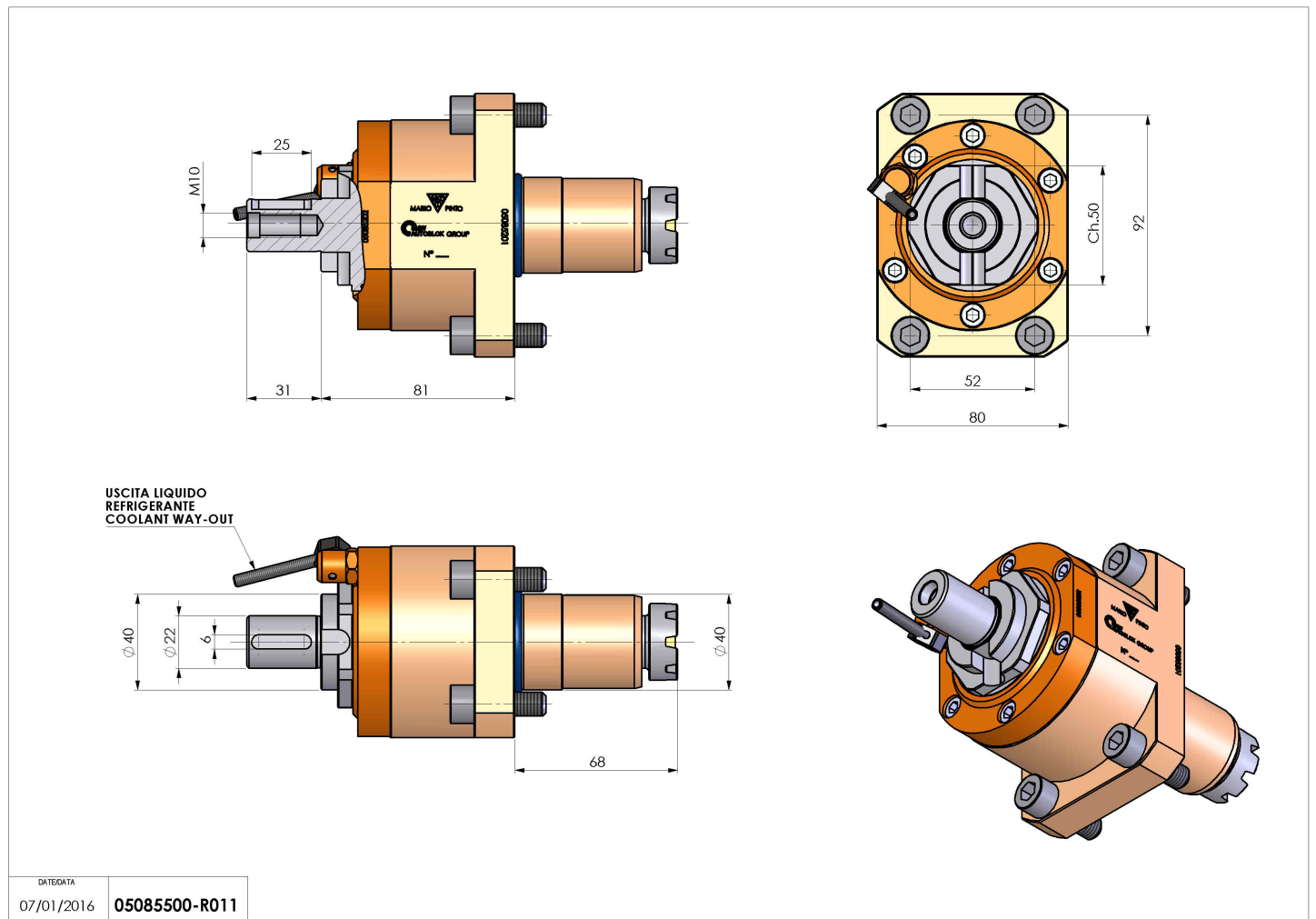

DATE/DATE
07/01/2016 05085500-R011

Subject to technical changes