

05078500 - LT-S D60 ER25 H73

Type	LT-S Tool holder straight
Mounting	CYLINDRICAL SHANK 60
Tool output	Collet nut ER 25
Coolant	External coolant
Direction of rotation	r1 ↻ r2 ↻
Max speed [rpm]	6000
Max torque [Nm]	63
Ratio	1:1
H [mm]	73
Accessories	N.A.
Notes	N.A.
Mounting tips	N.A.

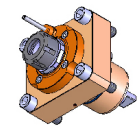

Always check live tool dimensions on the turret

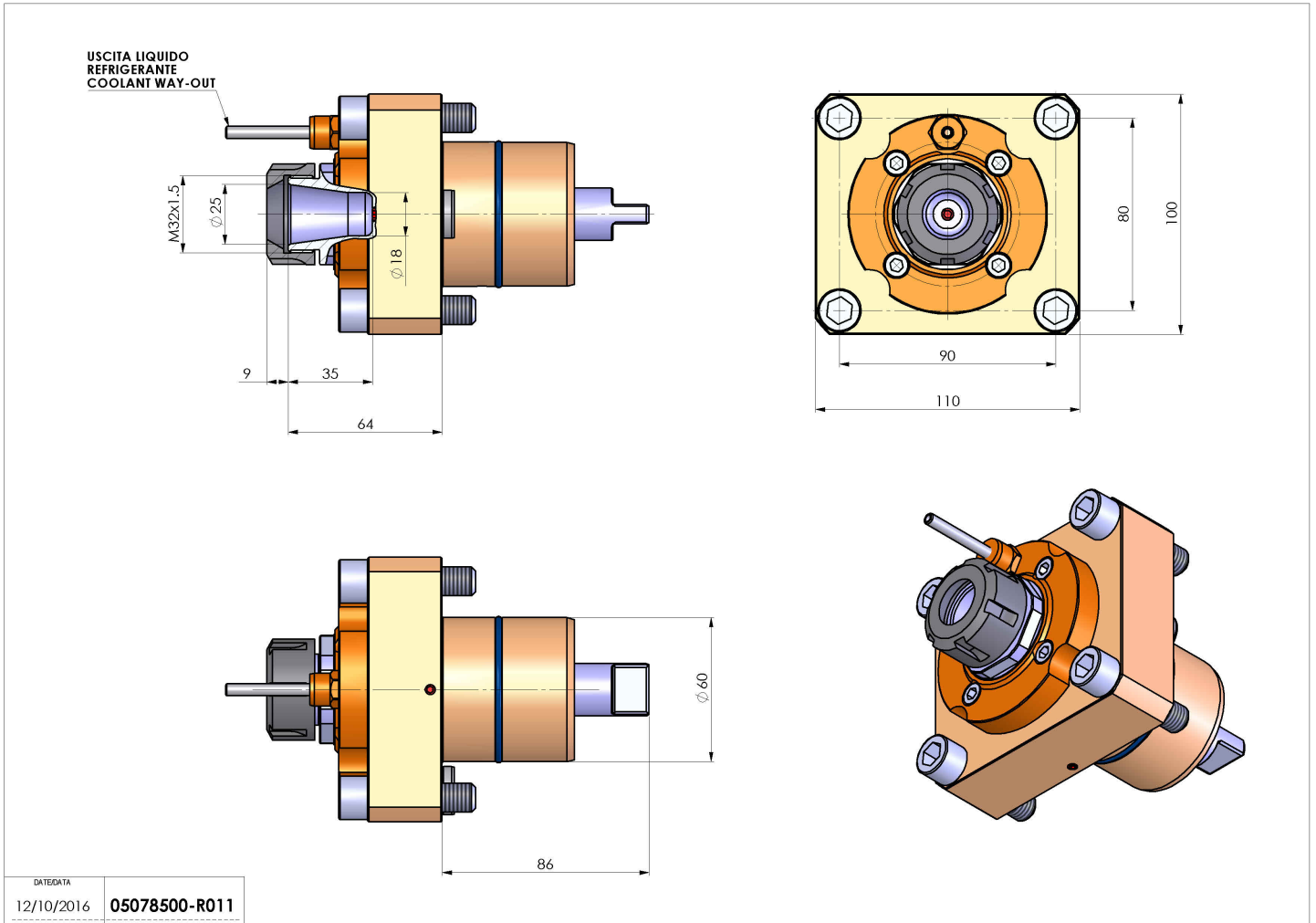

DATE/DATE	05078500-R011
12/10/2016	

Subject to technical changes