

# 05073300 - LT-A D55 ER25 LR RF H70 BI

Type	LT-A Tool holder angle 90°
Mounting	CYLINDRICAL SHANK 55
Tool output	Collet nut ER 25
Coolant	Internal coolant
Direction of rotation	r1 ↻ r2 ↻
Max speed [rpm]	6000
Max torque [Nm]	40
Ratio	1:1
H [mm]	70
H1 [mm]	32,5
Max pressure [bar]	20
Accessories	N.A.
Notes	N.A.
Mounting tips	Main and secondary spindle

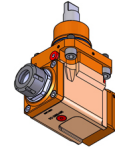

Always check live tool dimensions on the turret

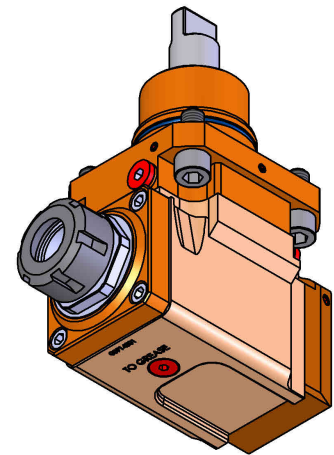
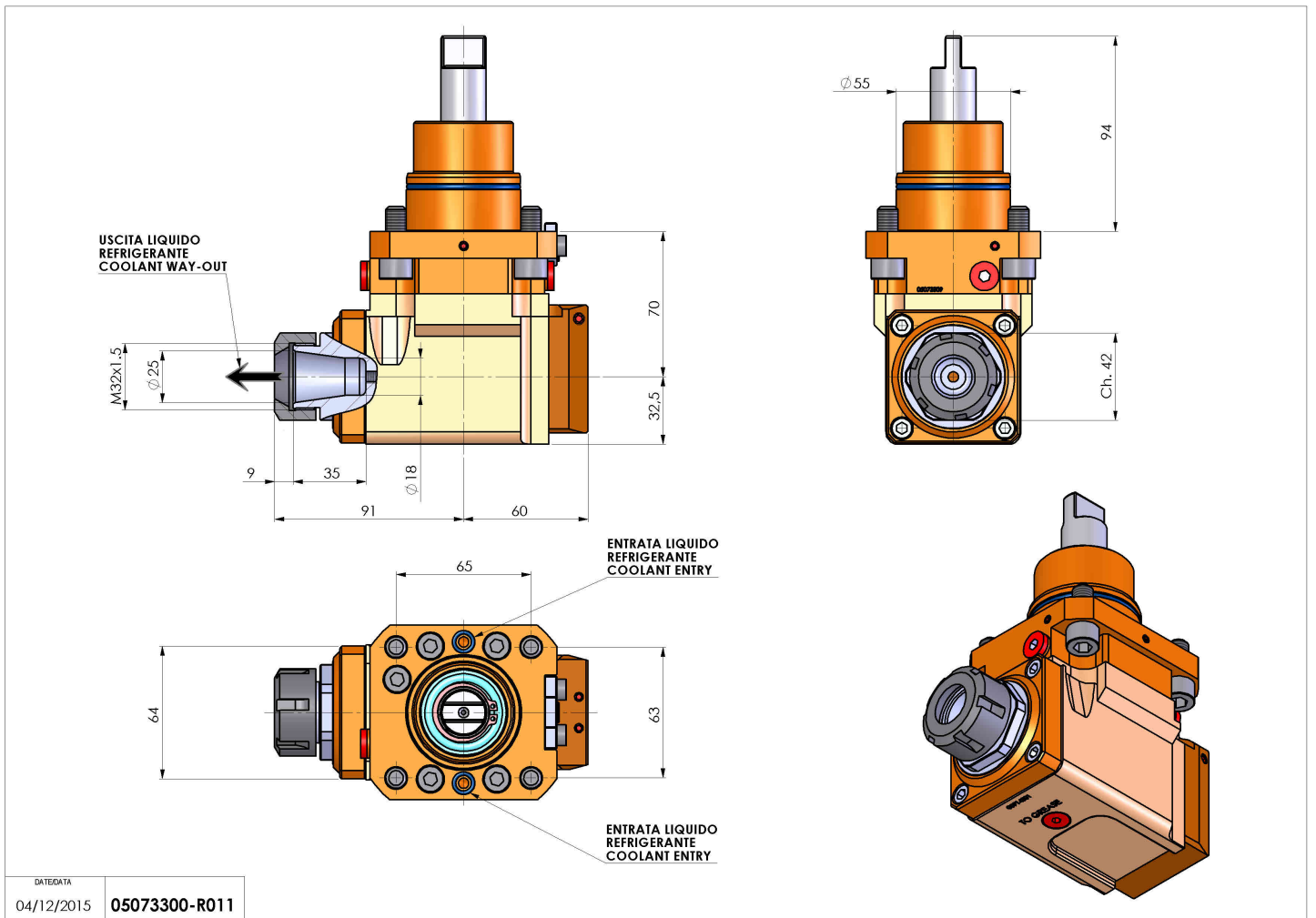

Subject to technical changes

DATE/DATE: 04/12/2015  
PART NUMBER: 05073300-R011