

05072800 - LT-S D55 ER32 RF H75 BI

Type	LT-S Tool holder straight
Mounting	CYLINDRICAL SHANK 55
Tool output	Collet nut ER 32
Coolant	Internal coolant
Direction of rotation	r1 ↻ r2 ↻
Max speed [rpm]	6000
Max torque [Nm]	63
Ratio	1:1
H [mm]	75
Max pressure [bar]	20
Accessories	
Notes	N.A.
Mounting tips	N.A.

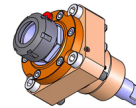

Always check live tool dimensions on the turret

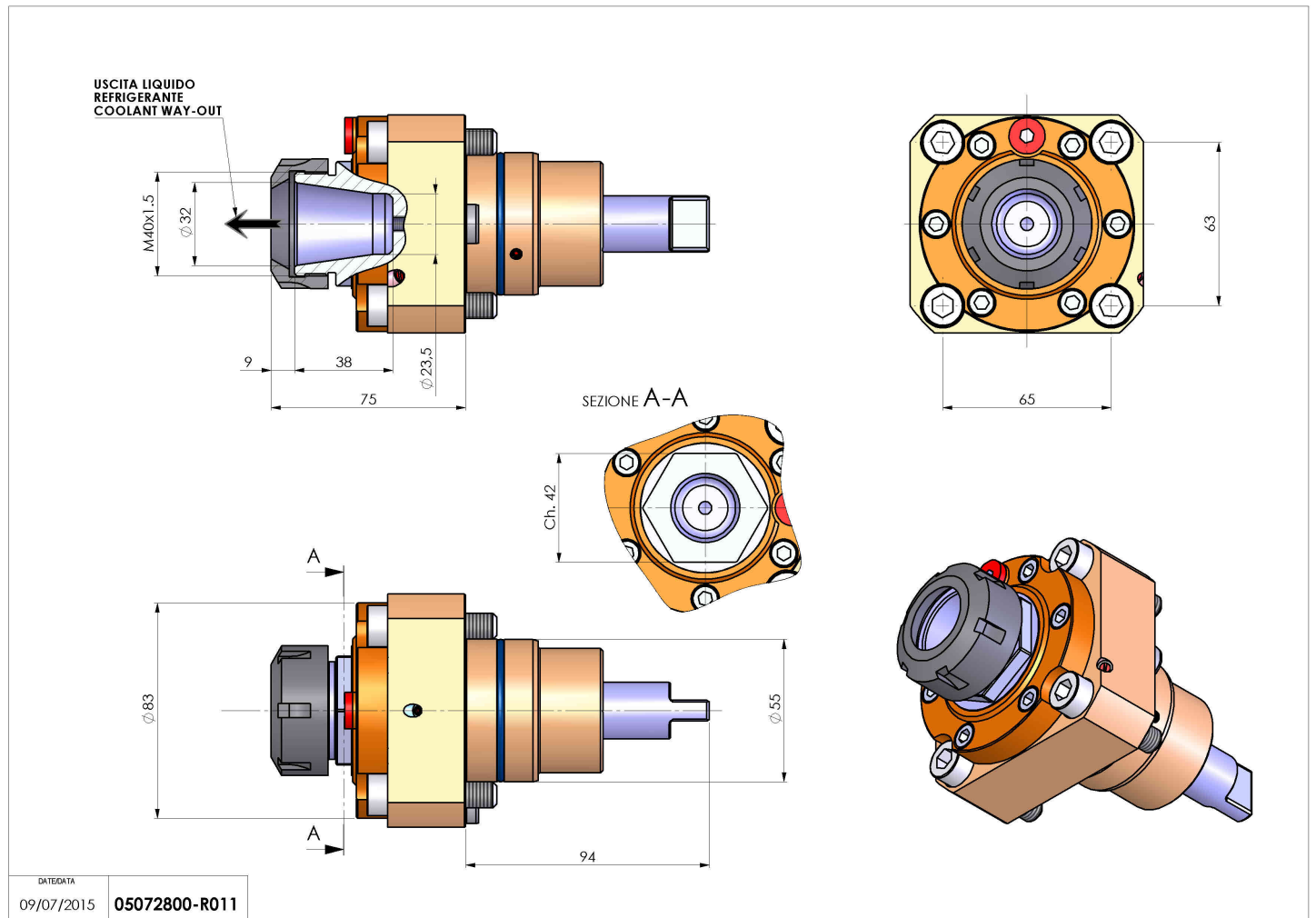

Subject to technical changes